



Ergokit

Force gauges for ergonomics studies



Presentation of the Ergokit range

Digital force gauges for ergonomic measurements

Excessive forces, repetitive shock and high physical efforts have been identified as contributors to traumatic and overuse injuries. Therefore, Andilog has developed the Ergokit product line in order to measure the forces which occur on the the body during various activities and can be used in order to conduct ergonomic analysis. The Ergokit product line measures with high accuracy the force load required by the human body to perform work tasks such as lifting, pushing, pulling, moving things around, gripping, inserting clips and components etc.

The Ergokit are complete systems for every ergonomic measurement: they are already standard devices in the ergonomic field in the biggest groups of the automotive industry and various airports worldwide.

The Ergokit range comes in four versions:

Ergokit FIRST II



- Easy handling
- Saves the maximum force (load, initial force) in tension and compression
- The force can be applied manually during the measurement.
- No possibility to connect to the computer
- Capacity: 500 N

Ergokit EASY



- Internal memory 500 values with calculation of average and standard deviation
- Internal memory download to a computer possible
- High accuracy
- Threshold value adjustment with acoustic alarm in case of an exceeded value
- Capacities: 500 N and 1 000 N

Ergokit STAR TOUCH



- Advanced force gauge for extensive measurements
- Internal memory 2 000 values, automatic calculation of maximum force (initial force) and average force (holding force) with statistical calculations
- Curve display on the color touch screen with computer and USB transfer options for subsequent detailed processing of the results
- Capacities: 500 N and 1 000 N

ERGOBAR

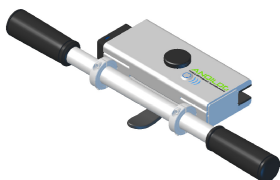

- **New: data transmission via Bluetooth!**
- Optimized handling for tests handling trolleys, pallet truck...
- Sampling frequency up to 1.000Hz
- Wireless range up to 20 meters
- Automatic calculations in real time
- Plot the curve directly on your computer
- Capacity 1 000N

Presentation of the Ergokit FIRST & EASY

Ergokit FIRST II



Simple digital force gauge for ergonomic measurements

The force gauge Ergokit First II is a simple and yet complete digital force gauge which uses efficient technology to simplify force measurements, in tension and compression. The display shows the force measured in tension or compression in the unit selected by the operator: newtons, kilograms or pounds. The bar graph completes the measurement.

The three keys make it very easy to use this force gauge and access the essential functions: measurement of the peak tension or compression value, resetting to zero, and changing the measuring units. It is an ideal tool for basic tests during production. Its metal casing, protected by an elastomer hull, gives it exceptional strength.

Our Ergokit First II is specially designed to suit any measurement situations encountered on the workstation: pulling, pushing, pressing with one's hand...

Ergokit EASY

Graphical ergonomy kit

The Ergokit Easy is ideal for a direct reading of the maximum value and the current value simultaneously.

It also enables two limits to be programmed to sound an alarm, which is essential to any precise measurement when checking for conformity to regulations. Its highly efficient measurement chain enables it to use a sampling rate of 2,000 Hertz with a resolution of 1/10,000 FS and a total error of less than 0.1% FS.

Thanks to its statistical functions allowing 500 values to be saved and the average value and the standard deviation to be displayed, it is easy to immediately determine the repeatability of the measurements Memory can be download to Microsoft Excel using the included software RSIC LAB.



All the Ergokit are delivered with their transport casing, accessories, power supply and certificate of calibration.

Functions	Ergokit First II	Ergokit Easy
Measuring range	500 N / 100 lbs	500 N / 100 lbs 1000 N / 200 lbs
Accuracy	0.25% FS	0.1% FS
Resolution	1/ 5,000 FS	1/ 10,000 FS
Sampling rate	1,000 Hz	2,000 Hz
Sensor protection	150% FS	150% FS
Units	N, Kg, Lb	N, Lb, Kg, g, Oz
Internal memory	1 value	500 values
Actual value & peak	Simultaneously	Simultaneously

Presentation of the Ergokit STAR

Ergokit Star



Advanced force measurement from 0 to 1000 N (0-200 lbs)

The force gauge Centor Star Touch is the key element of the package Ergokit. **It displays the curve of your test with 2 calculations in real time**, for instance the average force, the force at a given time, the peak force, the break force etc. Of course it can also show the actual and maximum value (ex: the fitting force) and limits can be activated with an audible signal. The internal storage can save up to 2 000 statistics and calculations.

The Ergokit Star can measure up to 1.000 N (200 lbs.)

Threshold feature

The Ergokit Star has a function that allows you to set force measurement limits. This system offers the possibility to set a low threshold and a high threshold for the limit.

The configured thresholds appear automatically on the bar graph and the graph during the tests during measurements. Similarly, **the display color of the measured value changes from green, orange or red when the limits are exceeded.**

In addition, the force gauge can perform an action when it reaches a limit: emission of a beep, change of color on the screen that allows the operator to be easily informed that a limit is reached, activation of digital outputs on the limits. This allows for example to stop the measurement when a part has been inserted in a system.

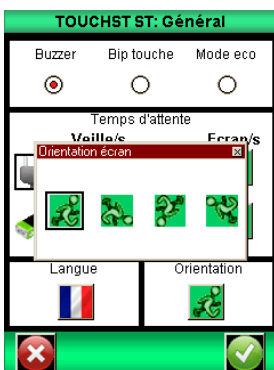
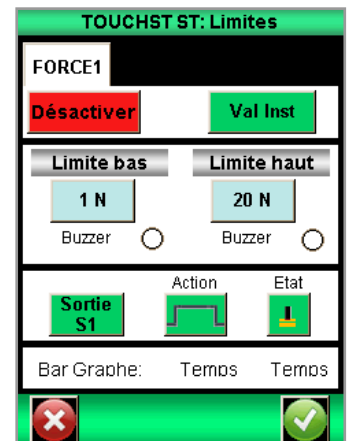

Swivel screen

The display of the Centor Touch Star can be adjusted by internal software. It can be rotated 90°, 180° or 270°.

This operation is done directly from the Centor Touch menu. No mechanical disassembly or modification is necessary to change the position of the screen.

This function can be useful if the tests are done horizontally or if you want to integrate the force gauge in a control panel.

Datastick II - The portable data saving solution for your tests



Thanks to the new Datastick II you can now count on a real portable solution to save easily all of your tests.

The software Datastick II and its USB stick help you save automatically or on demand the results (calculations, statistics) and the curves of your tests on an USB stick of your choice. The included software enables you to visualize the curves and measurement data on your computer and benefits from the performance of Caligraph.

The software Datastick II and its USB stick help you save automatically or on demand the results (calculations, statistics) and the curves of your tests on an USB stick of your choice.

The included software allow you to visualize the curves and measurement data on your computer and benefit from the performance of Caligraph. You can import the data saved, compare the curves and tests results and finalize your measurements with the editing of PDF or Word reports. Datastick II is user friendly and plugged in the connector of the housing thanks to its adapter and the setting takes place through the interface of the Centor.

It is a complete solution for tests in the field and it is adapted to the demanding needs for better result traceability. You can also export the points of the curves in Excel.

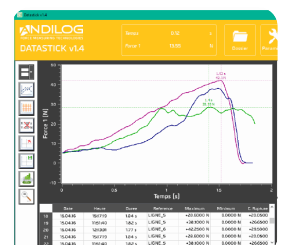

Ergokit Star with external load cell

Force and torque sensors dedicated to your applications



Multiple sensors with a single display

Aside from ergonomic measurements, if you need to use sensors to evaluate the opening torque on fastening parts, control the compression force of a mechanical press or check the dynamic torque on small rotating parts for instance, you can do it with the Ergokit Star using its "SPIP" output.

This type of sensor is automatically recognized by all gauges Centor Star and Dual. **The sensor characteristics are stored in its internal memory.** When the Centor Star or Dual is turned on, its maximum capacity information and calibration data are collected in the main memory and the instrument is automatically configured.

SPIP sensors allow to complete your force and torque measuring instruments at a very reasonable price.

Here is an overview of the standard sensors offered by Andilog. For more detailed information, visit our website:

Ref.	Capacity	Accuracy	Resolution	Height	Width	Length	Thread
	N / LBS	% FS	FS	MM / IN	MM / IN	MM / IN	
SPIP S2	10-1000 / 2-20	0,1	1/10,000	60 / 2.36	25.4 / 0.98	80 / 3.15	M8
SPIP S9	1-50000 / 200-10,000	0,1	1/10,000	62 x 87 x 100 / 2.44 x 3.42 x 3.93	24 x 31 x 36 / 0.94 x 1.22 x 1.42	50 x 57 x 69 / 1.97 x 2.24 x 2.72	M8, 12 or M24 x 2

Ref.	Capacity	Accuracy	Resolution	Height	Diameter	Thread
	NM / LB.IN	% FS	FS	MM / IN	MM / IN	Opening in MM / IN
SPIP LLB 130	20-200 / 5-50	0,5	1/10,000	3,30 / 0.13	9,53 / 0.35	/
SPIP U9C	50-50000 / 100-10,000	0,5	1/10,000	44-84 / 1.73-3.30	26-46 / 1.02-1.81	M5 / M10 / M16

Ref.	Capacity	Accuracy	Resolution	Lenght	Diameter	Square/ Chuck
	NM / LB.IN	% FS	FS	MM / IN	MM / IN	Opening in MM / IN
SPIP TH	0,3-12 / 2.5-100	0,5	1/10,000	88 / 3.46	44 / 1.73	1,5-10 / 0.04-0.39
SPIP TW	15-150 / 150-1500	0,5	1/10,000	340 - 493 / 13.39-19.40	/	Male 3/8 or 1/2
SPIP DT	6-150 / 50-1500	0,5	1/10,000	75 x 28 x 52 / 2.95 x 1.10 x 2.04 or 75 x 38 x 58 / 2.95	/	1/4 or 3/8 or 1/2

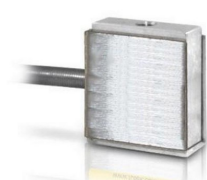
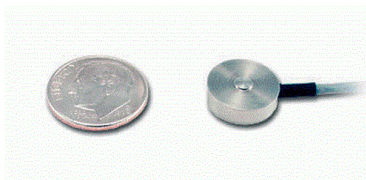

Display with external load cell

Force gauge ERGOBAR - Measurement on handling trolleys

A unique solution for the force measurement on handling trolleys

The Ergobar is the newcomer of the product range Ergokit. This **portable force gauge up to 1,000 N (115 lbs)** with two handles has been specifically designed to answer the needs of ergonomists and occupational physicians wishing to measure the push and pull force on trolleys such as food trolleys, containers, forklifts, hospital beds and every other system of handling assistance for commodities or people.

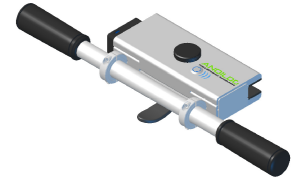

It enables to perform repeatable force measurements and gives indications on the initial and roller force with a resolution of 0,1 N (1/10.000 FS).

The Ergobar is an essential force gauge to determine which trolley is best suited for the working environment and the task to conduct (thermal constraints, obstacles, degraded floors, material of the wheel, brakes etc.). It is also a key tool for the ergonomic studies which provides you with concrete results for your proposals for improvement and the optimization of the working conditions: determining the ideal weight of the loads to move, the travel speed, the slope steepness, the congestion of the working space, the gap between the elevator sill and the floor etc.

It is a highly precise device, easy to use and to install on various types of trolleys, which offers an optimal follow-up of the force data: **the Ergobar is the most practical and indispensable solution for purposes of improving the in-house ergonomic of your company.**

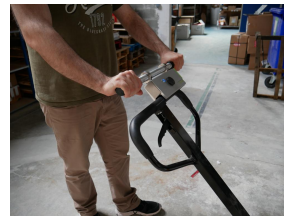
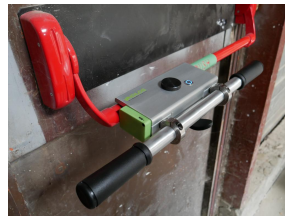

Data transmission via Bluetooth

Connect your Ergobar to your computer or your Centor Touch, click on the start button and start your measurements!

The data transmission of your force measurements occurs wirelessly thanks to the Bluetooth transmitter integrated in the Ergobar. The high **sampling rate (up to 1.000 Hz)** ensures detailed results for a sharp analysis of your curves.

The force VS time curve is plotted instantaneously on the software Caligraph and up to 4 calculations can be displayed on your computer. You can choose between Newton (N), decanewton (daN), kilograms (Kg) or pounds (lbs). It is also possible to **program force thresholds** with an acoustic and visual signal for a better control of the pushing/pulling forces that should not be exceeded.



Visualize, compare and work on your measuring curves with Caligraph



Caligraph enables you to select the curve of each measurement to visualize them. The comparison is facilitated by the various graphic tools (i.e. color, size). You can add up to 5 markers on the curves and comments such as the degree of slope, the congestion of the working space, the floor material etc.

The pre-registered calculations are displayed below the graphic and/or on the curve. The average and the standard deviation of the selected tests is done automatically above the results table.

Caligraph also provides an editor for your ergonomic analysis. The selected data can be exported in PDF or Word in personalized reports with the logo of your company, headings and footers. Of course, the points of the curves can also be exported into Excel or Matlab for ulterior analysis.

With Caligraph you ensure the traceability and the detailed follow-up of your ergonomic measurements for your push and pull tests.

Technical specifications

Specifications of the Ergokit Star

Overload protection	150% FS
Available units	N, Lb, Kg, g, Oz, Nm, mNm, lbin, lbft, inoz
Bargraph	√
Autonomy without recharge	8 hours
Memory	2,000 results
Sampling rate	5 000 Hz internal 1 000 Hz SPIP 500 Hz WLC
Computer connection	USB, RS232
USB transfer rate	1,000 Hz
RS232 transfer rate	100 Hz

Traction/compression measurement	√
Peak measurement	√
Calculations	Peak, Average, Break
Auto-off	Adjustable duration
Programmable thresholds	√
Reversible display	90° and 180°
Configurable display	Up to 3 lines
Transport case	√
Switching outputs 5V	6
Switching inputs 5V	3
Supply voltage	110 / 220 V
Datastick (USB Stick and software)	Included

Housing dimensions of the Ergokit

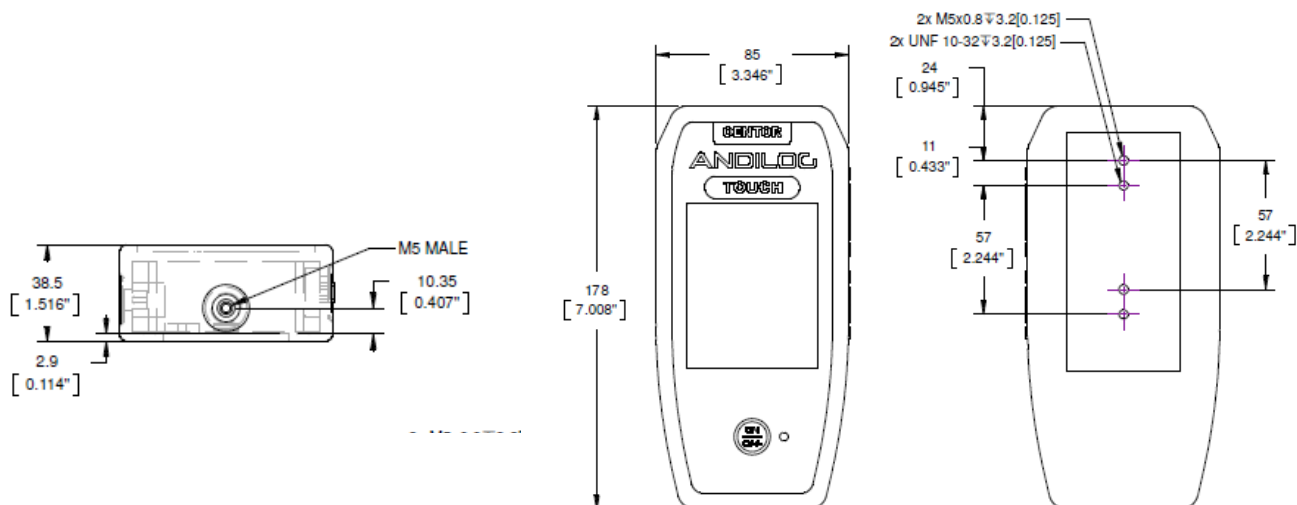

System delivered with

- Force gauge Centor First II, Easy II, Touch or Ergobar
- Accessories package for the gauges with display including: hook, platen, extension rod, sling, probe, double handle, neck or shoulder strap
- Carrying case
- 110V / 220V power charger
- Calibration certificate (via Email)

Ergokit

Force gauges for ergonomics studies



ISO 9001:2015 Certified

HEADQUARTERS

ANDILOG
BP62001
I 3845 VITROLLES CEDEX
info@andilog.com
www.andilog.com
Tél : +33 442 348 340

USA

ANDILOG / COM-TEN
6405 49th St North
Pinellas Park, FL, 33781
sales@com-ten.com
www.andilog.com
Tél : +1 72705201200